

Placed on bottom

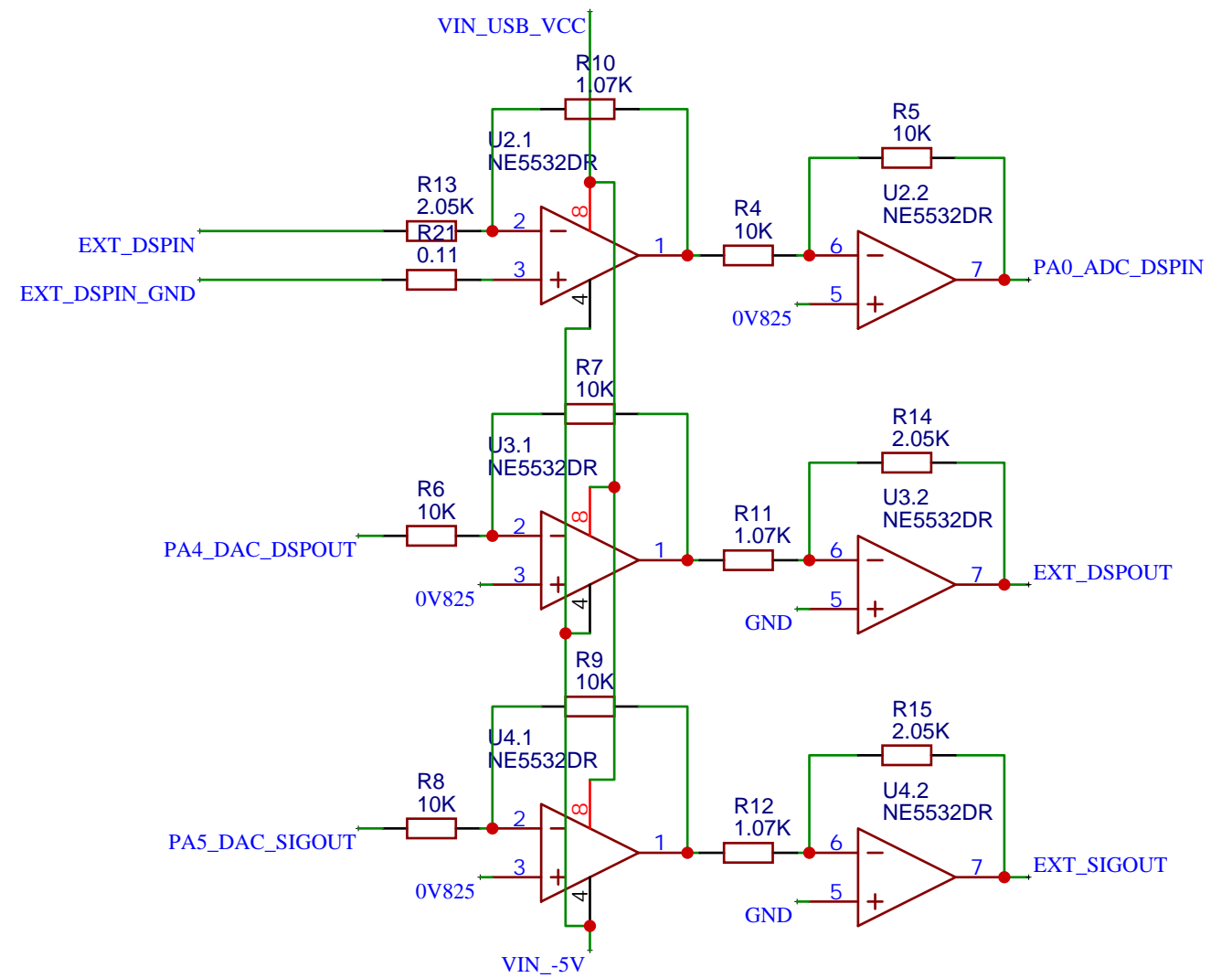
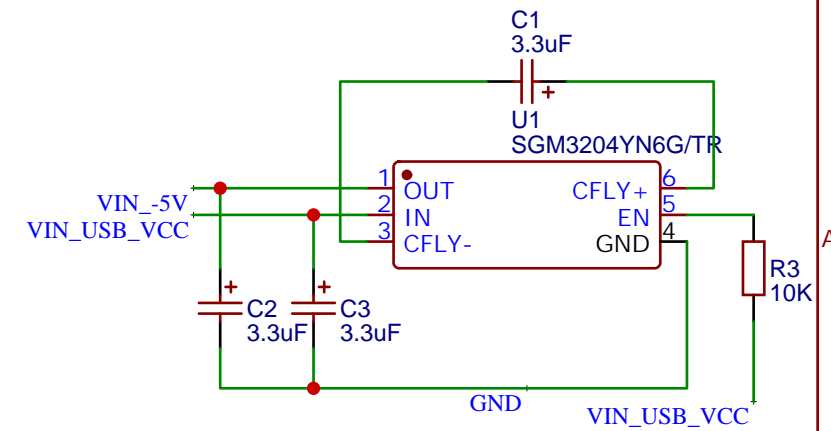
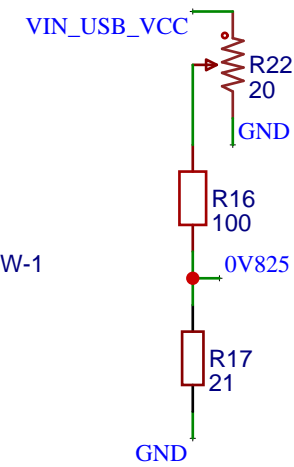
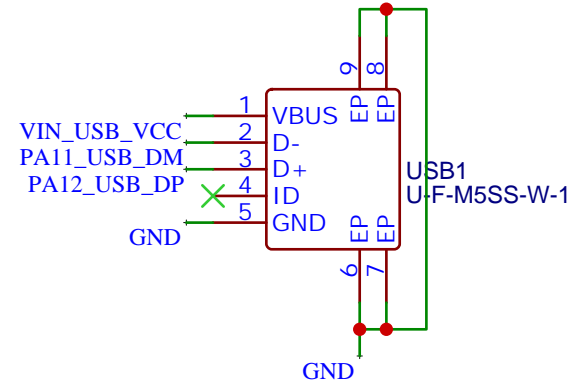
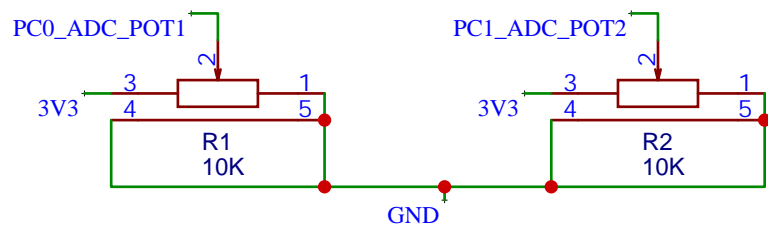
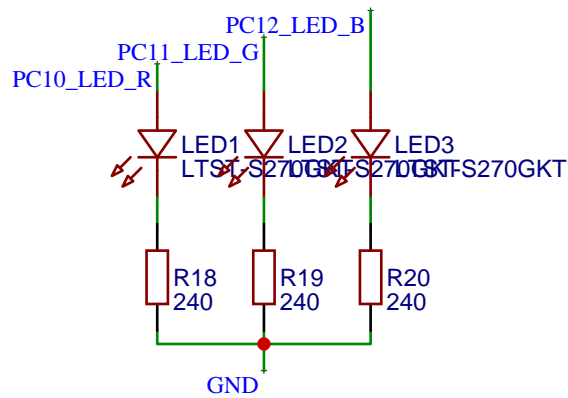
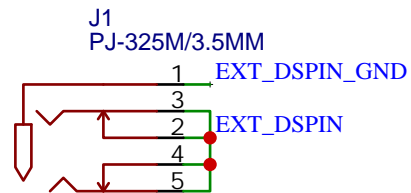
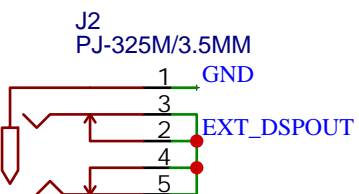
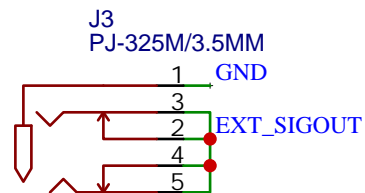
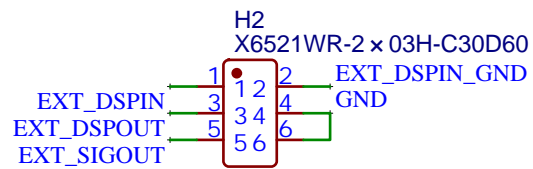
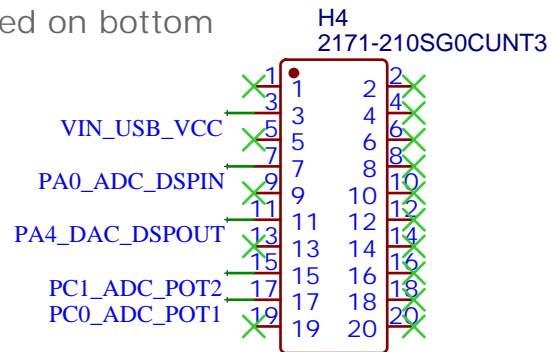

TITLE: stmdsp add-on board		REV: 1.0
EasyEDA	Company:	Sheet: 1/1
	Date: 2021-03-20	Drawn By: Clyne Sullivan